

# SCARIFIER TOOL BAR w/ PARALLEL HOOKS

HENKE MODEL: STB w/PH  
For Motor Graders

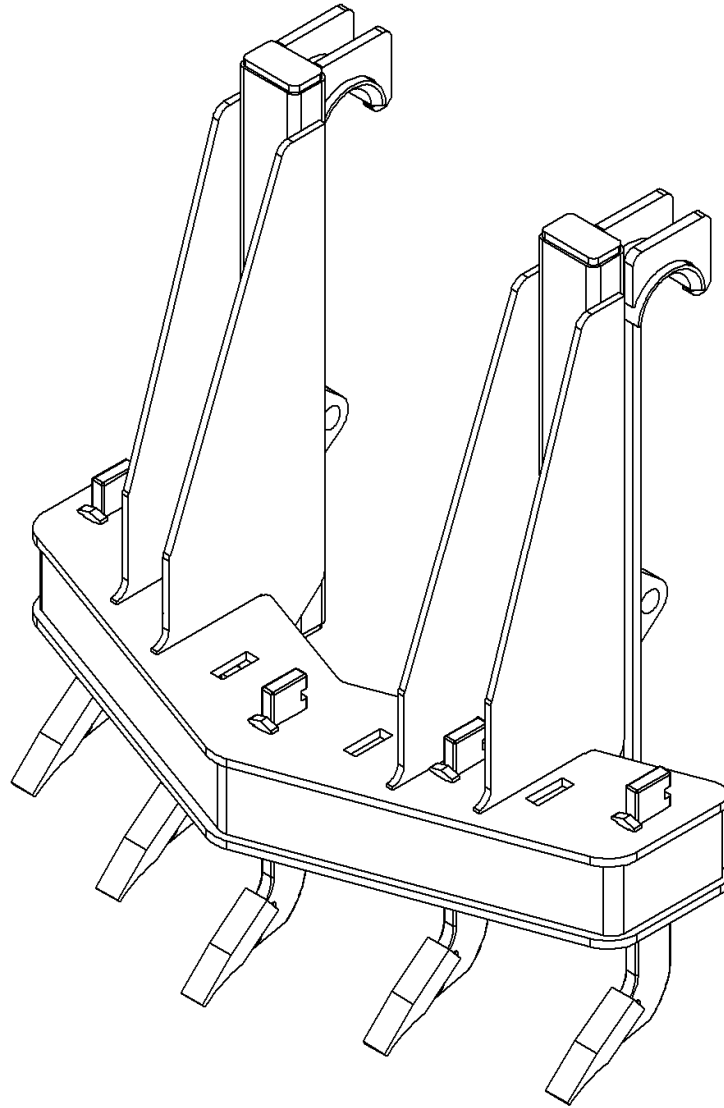

SERIAL NUMBER \_\_\_\_\_

**PARTS BOOK AND INSTALLATION MANUAL  
VERSION 1.0, NOVEMBER 2012**



**HENKE MANUFACTURING CORPORATION**

MANUFACTURERS OF SNOW REMOVAL EQUIPMENT FOR 90 YEARS

3070 WILSON AVE. LEAVENWORTH, KS 66048 PHONE (913)682-9000 FAX (913)682-0300

WEBSITE ADDRESS: [WWW.HENKEMFG.COM](http://WWW.HENKEMFG.COM) EMAIL: [PARTS@HENKEMFG.COM](mailto:PARTS@HENKEMFG.COM)

## **Introduction**

Thank you for your purchase of a Henke Scarifier Tool Bar for your snow fighting needs.

Please read this manual in its entirety before installing or operating the Tool Bar.

If any items appear to be missing, or if you need assistance of any kind, please call Henke Manufacturing at (913) 682-9000 or toll-free at (888) 682-9010.

NOTE – All references to “Left” or “Right” in this manual refer to the view from the drivers’ position.

## Table of Contents

Introduction .....	2
Safety Section..... (Section 1)	4
Maintenance.....	5
Cutting Edges, Curb Guards, Wear Guards .....	9
Henke Warranty & Dealer Warranty Procedure .....	12

### Figures

FIGURE 1 – Henke Scarifier Tool Bar for Motor Graders .....	COVER
FIGURE 2 – Henke Scarifier Tool Bar Parts View .....	8

### Tables

TABLE 1 – Henke Scarifier Tool Bar, Parts List.....	8
TABLE 2 – Cutting Edges .....	9
TABLE 3 – Cutting Edge Hardware.....	10
TABLE 4 – Henke Curb Guard & Wear Guards .....	11

<<THIS PAGE IS INTENTIONALLY LEFT BLANK>>

# **SAFETY SECTION**

PLG - Lift Groups  
AQC - Quick Coupler  
STB - Scarifier Tool Bar  
Truck Hitches

Safety Section 1-1

# SAFETY

## GENERAL SAFETY INSTRUCTIONS AND PRACTICES

A careful operator is the best operator. Safety is of primary importance to the manufacturer and should be to the owner/operator. Most accidents can be avoided by being aware of your equipment, your surroundings, and observing certain precautions. The first section of this manual includes a list of Safety Messages that, if followed, will help protect the operator and bystanders from injury or death. Read and understand these Safety Messages before assembling, operating or servicing this Implement. This equipment should only be operated by those persons who have read the manual, who are responsible and trained, and who know how to do so responsibly.



The Safety Alert Symbol combined with a Signal Word, as seen below, is used throughout this manual and on decals which are attached to the equipment. The Safety Alert Symbol means: "ATTENTION! BECOME ALERT! YOUR SAFETY IS INVOLVED!" The Symbol and Signal Word are intended to warn the owner/operator of impending hazards and the degree of possible injury faced when operating this equipment.

Practice all usual and customary safe working precautions and above all---remember safety is up to YOU. Only YOU can prevent serious injury or death from unsafe practices.



Indicates an imminently hazardous situation that, if not avoided, WILL result in DEATH OR VERY SERIOUS INJURY.



Indicates an imminently hazardous situation that, if not avoided, COULD result in DEATH OR SERIOUS INJURY.



Indicates an imminently hazardous situation that, if not avoided, MAY result in MINOR INJURY.

**Important**

Identifies special instructions or procedures that, if not strictly observed, could result in damage to, or destruction of the machine, attachments or the environment.

**NOTE:** *Identifies points of particular interest for more efficient and convenient operation or repair.* (SG-1)

READ, UNDERSTAND, and FOLLOW the following Safety Messages. Serious injury or death may occur unless care is taken to follow the warnings and instructions stated in the Safety Messages. Always use good common sense to avoid hazards. (SG-2)



# SAFETY

## **WARNING**

Repeated or substantial breathing of hazardous dusts, including crystalline silica, could cause fatal or serious respiratory disease including silicosis. Concrete, masonry, many types of rock, and various other materials contain silica sand. California lists respirable crystalline silica as a substance known to cause cancer. Operation of this equipment under certain conditions may generate airborne dust particles that could contain crystalline silica. In those conditions, personal protective equipment including an appropriate respirator must be used. If excessive dust is generated, a dust collection or suppression system should also be used during operation. (SG-41)

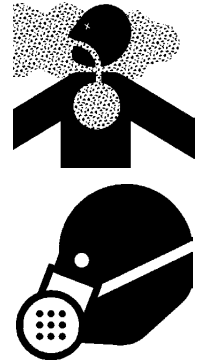

## **PELIGRO**

Si no lee ingles, pida ayuda a alguien que si lo lea para que le traduzca las medidas de seguridad. (SG-3)

**¡ LEA EL INSTRUCTIVO!**



## **DANGER**

Never operate the Snow Plow until you have read and completely understand this Manual, the Truck or Power units Operator's Manual, and each of the Safety Messages found in these Manuals and those affixed to the Snow Plow, Truck, or Power units and its components. Learn how to stop the power unit engine suddenly in an emergency. Never allow inexperienced or untrained personnel to operate the Truck or Power unit and Snow Plow without supervision. Make sure the operator has fully read and understood the manuals prior to operation. (SPNG-4)

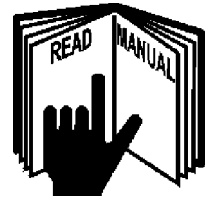

In addition to the design and configuration of this Snow Plow, including Safety Signs and Safety Equipment, hazard control and accident prevention are dependent upon the awareness, concern, prudence, and proper training of personnel involved in the operation, transport, maintenance, and storage of the machine. Refer also to Safety Messages and operation instruction in each of the appropriate sections of the Truck or Power unit Manuals. Pay close attention to the Safety Signs affixed to the Snow Plow. (SNPG-5)

## PARTS INFORMATION

HENKE Snow Plows use balanced and matched system components for plows, carriers, and other components. These parts are made and tested to HENKE specifications. Non-genuine or "will fit" parts do not consistently meet these specifications. The use of non-genuine or "will fit" parts may reduce Snow Plow performance, void HENKE warranties, and present a safety hazard. Use genuine HENKE parts for economy and safety. (SNPG-6)

## SEE YOUR HENKE DEALER

## **WARNING**

Always maintain the safety signs in good readable condition. If the safety signs are missing, damaged, or unreadable, obtain and install replacement safety signs immediately. (SG-5)

**SAFETY**

# SAFETY<sub>L</sub>



All Safety Shields, Guards and other Protective Safety devices should be used and maintained in good working condition. All safety devices should be inspected carefully at least daily for missing or broken components. **NEVER REMOVE PROTECTIVE SHIELDS AND GUARDS! NEVER MODIFY OR CUT PROTECTIVE SHIELDS OR GUARDS!** When shields or guards are removed to access areas for maintenance, they must be replaced and be in good condition before operating. Missing, broken, or worn shields, guards, and other protective devices must be replaced at once and prior to operation to reduce the possibility of injury. (SNPS-02)



The Snow Plow power unit should be equipped with a fire extinguisher, rated for all fires, in an accessible and visible area. The fire extinguisher should be inspected routinely by a certified inspector for operational use and replaced as needed. Never obstruct access to the fire extinguisher. (SNPS-6)

## **OPERATOR SAFETY INSTRUCTIONS AND PRACTICES**



**NEVER use drugs or alcohol** immediately before or while driving or operating the Snow Plow. Drugs and alcohol will affect an operator's alertness and coordination and therefore affect the operator's ability to operate the Equipment safely. Before operating the Equipment, an operator on prescription or over-the-counter medication must consult a medical professional regarding any side effects of the medication that would hinder their ability to operate the Equipment safely. **NEVER** knowingly allow anyone to operate this Equipment when their alertness or coordination is impaired. Serious injury or death to the operator or others could result if the operator is under the influence of drugs or alcohol. (SNPD-3)



Always wear OSHA approved Personal Protective Equipment (PPE) while operating, servicing, repairing, and/or cleaning the Equipment. PPE is designed to provide bodily protection during such activities.

Personal Protective Equipment includes:

- Protective Eye Wear
- Steel Toed Safety Footwear
- Gloves
- Hearing Protection
- Close Fitted Clothing
- Hard Hat-When working around a raised hopper.
- Respirator-Depending on conditions and material being swept or cleaned.

Specialized protective equipment may be required if dangerous or hazardous material is being moved by the plow. (SNPD-4)



# SAFETY

## CAUTION

Prolonged operation of the Snow Plow may cause operator boredom and/or fatigue affecting the safe operation of the Snow Plow and Truck or Power unit. It is recommended that the operator take scheduled work breaks to help prevent these potentially impaired operating conditions. If possible, completely shut down the Equipment, exit the cab and move around stretching your arms and legs. Never operate the Equipment in a fatigued or bored mental state that impairs proper and safe Equipment operation. (SNPD-5)

## CAUTION

**PROLONGED EXPOSURE TO LOUD NOISE MAY CAUSE PERMANENT HEARING LOSS!** Equipment operation can often be noisy enough to cause permanent hearing loss. We recommend that you always wear hearing protection if the noise in the Operator's position exceeds 80db. Noise over 85db over an extended period of time will cause severe hearing loss. Noise over 90db adjacent to the Operator over an extended period of time will cause permanent or total hearing loss. **Note:** *Hearing loss from loud noise [from sweepers, chain saws, radios, and other such sources close to the ear] is cumulative over a lifetime without hope of natural recovery.* (SNPD-6)



## CAUTION

Prolonged operation of the Equipment in cold weather may cause operator hypothermia affecting the safe operation of the Snow Plow and Truck or Power unit. It is recommended that the operator wear appropriate clothing take scheduled work breaks to help prevent these potentially impaired operating conditions. If possible, completely shut down the Equipment, exit the cab and warm the body in a properly heated area. Never operate the Equipment in a fatigued or impaired mental state that effects the proper and safe Equipment operation. (SNPD-8)

## WARNING

Use both hands for support when getting on and off the truck or power unit. Use handles and steps on the equipment for support when boarding. Never use the Truck or Snow Plow control levers for support when boarding the equipment. (SNPO-01)

## WARNING

Use available truck or power unit handles and steps to exit the operator's station. Make sure you have solid footing before stepping down. Be careful of your step and use extra caution when mud, ice, snow, or other matter has accumulated on the steps or handrails. Never rush to exit or jump off the truck or power unit. (SNPO-02)

## DANGER

Do not attempt to mount the Truck or Power Unit while the machine is moving. Never attempt to mount a runaway Snow Plow. Serious injury or death may occur from being run over by a moving Truck, Power Unit, or Snow Plow. (SNPO-03)

## DANGER

**BEFORE** leaving the operator's seat, always engage the parking brake and/or set the Truck's or Power Unit's transmission in the park position, stop the engine, remove the key, and wait for all moving parts to stop. Never dismount a Truck or Power Unit that is moving or while the engines are running. Operate the equipment controls from the Operator's seat only. (SNPO-04)

# SAFETY

**⚠ WARNING**

Always wear a seat belt while driving the equipment during operation and transport. Serious injury or even death could result from falling from the operator's station or from being involved in a collision. (SNPO-05)

**⚠ DANGER**

Start the engines only when seated and belted in the operator's seat. Operate the equipment controls only while properly seated with the seat belt secured around you. Inadvertent movement of the power unit or attachment components may cause serious injury or death to the operator and passersby. Read the truck or Power Unit operator's manuals for proper starting instructions. (SNPO-06)

**⚠ DANGER**

Do not operate, or perform maintenance to, the Equipment while wearing loose fitting clothing. Entanglement of loose clothing with the rotating elements can result in serious injury or death. Stay clear of all rotating elements at all times. (SNPD-7)

**⚠ DANGER**

Operate only in conditions where you have clear visibility of the area in daylight or with adequate artificial lighting. Never operate in darkness or foggy conditions where you cannot clearly see at least 50 feet in front and to the sides of the equipment. Make sure that you can clearly see and identify passersby, steep slopes, ditches, drop-offs, overhead obstructions, power lines, oversized debris and foreign objects. If you are unable to see these types of items, discontinue operation until visibility improves. (SNPO-8)

**⚠ WARNING**

When transporting the Snow Plow between locations, follow all local traffic laws and regulations. (SNPO-10)

**⚠ WARNING**

Operate at a speed that allows you to safely operate and control the Truck and Snow Plow. Safe plowing speed depends on street condition and the type and amount of debris being moved. Slow down for corners, curbs, parked cars, protruding signs and other obstacles. Use slow traveling speeds when operating on or near steep slopes, ditches, drop-offs, overhead obstructions, power lines, or when debris and foreign objects are to be avoided. (SNPO-13)

**⚠ WARNING**

Do not operate the Equipment if excessive vibration or noise exists. Shut down the equipment and the Truck or Power Unit engine. Inspect the Equipment to determine the source of the vibration or noise. If parts are loose, damaged, or missing, replace them immediately. Do not operate the Equipment until all necessary repairs have been performed. To reduce the possibility of property damage, serious injury, or even death, never operate the Equipment with missing or damaged components. (SNPO-16)

**⚠ WARNING**

Never attempt to plow debris that is too large for the Snow Plow (oversized objects such as broken limbs and discarded tires). Such objects may damage the snow plow components and cause serious mechanical damage to the equipment. If possible, carefully place such objects out of the Snow Plow and traffic path until properly removed by another means. (SNPO-17)

# SAFETY

## WARNING

Unplowed snow, piled ice and debris, and snow drifts left behind the equipment might pose a driving hazard to vehicle traffic colliding with the debris or losing traction on the material. It is recommended to post warning signs alerting driver's of the equipment operation presence and the need to reduce vehicle speed. If such hazards are left behind following the Snow Plows passage, the area should be plowed a second time and any remaining hazards removed by an alternative method. (SNPO-19)

## DANGER

Do not allow the Snow Plow to come in contact with potentially dangerous and/or hazardous material. Such hazards may include, but are not exclusively limited to, the following:

- Fire Hazards- Fuel spills, burning material,
- Chemical Hazards- Chemical spills, discarded chemical containers, batteries,
- Biological Hazards- Decaying Carcasses, BioMedical Waste,
- Radioactive Hazards-Radioactive Waste, Radioactive Material,
- Carcinogenic Materials-Asbestos,
- Corrosive Materials-Batteries, Acids and Bases.

In most areas, these types of material require special handling requirements for safe and proper disposal and should not be plowed by the Snow Plow, nor can they be disposed of in a general landfill site like most swept waste. Contact the appropriate authority for the collection and disposal requirements of such dangerous and/or hazardous material. (SNPO-25)

## DANGER

Always wear required OSHA approved Personal Protective Equipment (PPE) when coming in contact with and removing potentially dangerous and hazardous material that has collected on the Snow Plow equipment or which is obstructing one or more components. Pay close attention to dangerous and hazardous material including, but not exclusively limited to, chemicals, decaying carcasses and sharp objects. (SNPO-26)

## WARNING

Verbal communication near a Truck or Power Unit and Snow Plow is difficult and dangerous. Operating instructions and directions should be made prior to starting the equipment. Unclear and misunderstood communication may lead to operator and bystander injury or death and equipment damage. If communication by the operator is necessary, completely shutdown and exit the equipment. Never allow anyone to approach the equipment while in operation. (SNPO-28)

## DANGER

Never allow children to play on, under, or around the Truck or Power Unit nor allow children to operate equipment controls. Children can slip or fall off the equipment and be injured or killed. Children can cause the equipment components to shift or fall crushing themselves or others. (SNPO-29)

## WARNING

Allow passengers only in situations where their presence is involved in the operation (operator training, supervision, maintenance inspection). Never carry passengers whose presence distracts from the safe operation or transport of the equipment. Passengers must be seated securely and belted in the cab's passenger seat. Never allow any person to ride on any other location of the Truck, Power Unit or Snow Plow during operation or transport. (SNPO-30)

# SAFETY



Extreme caution should be used by the operator when operating near passersby. Stop snow plowing if a passerby comes within 25 feet of the plow to prevent possible passerby injury or death from being struck by the equipment or from a thrown object. (SNPO-31)



Make sure that no bystander, animal or obstruction such as a vehicle, building, or street sign are within the width of the Snow Plow. The design of the Snow Plow may impair the operator vision when operating. Use extreme caution to ensure that the Snow Plow is not driven into the path of pedestrian or vehicle traffic. Serious injury or death and property damage could result from running into, being crushed by, or run over by a Snow Plow. (SNPO-33)



Make sure no bystanders or animals are within 25 feet of the equipment basket when dumping contents from or cleaning the Snow Basket. Bucket contents, which may exceed several thousand pounds, could fall and crush a bystander or an animal resulting in possible injury or death. (SNPO-34)



Use extreme caution when operating the Equipment in traffic. To alert motorists of the Equipment's presence, use all equipped warning signals to alert motorists and pedestrians of the equipment's presence and relatively slow speed. Serious injury or death and property damage may occur if a vehicle collides with this Equipment. (SNPS-3)



Before starting a snow plowing operation, make sure all the warning signal lights are connected, visible and working. Routinely inspect the equipment's headlights, brake lights, backup lights, and turn signal lights for operational condition. Immediately repair non-functioning lighting. Always follow all local traffic regulations while operating the Snow Plow. (SNPS-4)



Always turn on all safety lights and flashers when you operate the Snow Plow. (SNPS-5)



Be particularly careful in transport. The Implement has raised and moved the center of gravity to the front of the Power Unit increasing the possibility of overturn and tipping forward. Turn curves or go up slopes only at low speed and using a gradual turning angle. Go up slopes with the Implement located uphill. Slow down on rough or uneven surfaces. (SPU-2)

# SAFETY

## CONNECTING OR DISCONNECTING IMPLEMENT SAFETY INSTRUCTIONS AND PRACTICES



Do not stand or allow bystander or coworkers between the attachment and the truck or power unit while installing or disconnecting the attachment. Keep hands and body clear of the attachment and the attachment mounts. Serious injury or death can result from a person being crushed between the attachment and truck or power unit. (SNPC-01)

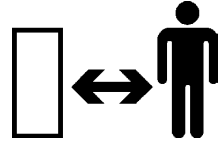

Reset the tripped snow plow edge by raising the snow plow off the ground. DO NOT attempt to reset the trip edge by hand. The trip edge is spring loaded and sudden and unexpected movement can occur resulting in serious injuries. Keep hands and feet away from the trip edge. If the trip edge does not reset, stop plowing and have the snow plow repaired before resuming snow plowing. (SNPO-12)



Make sure the implement is properly attached to the Power Unit and the retaining pins securely lock the Implement into position. Improper mounting of the Implement onto the Power Unit can result in the Implement falling causing serious injury. (SNPC-02)



The operator of the equipment must be trained in the operation and safe use of this machine. The operator must read and completely understand the operator's manuals of the Snow Plow, Truck or Power unit manufacturers. New operators should be trained in an open area clear of obstructions before operating on public roadways. If operation of the entire Snow Plow unit (Truck or Power unit) is not completely understood, consult your authorized sales representative for a detailed explanation. Never allow an untrained or unqualified driver to operate the Snow Plow. (SNPD-1)



The Snow Plow driver must meet the requirements and possess a Motor Vehicle License as determined by the state in which the Snow Plow is operated if used on public roadways. Contact your local State Department of Public Safety office for special licensing requirements to operate the Snow Plow in your area. (SNPD-2)

## MAINTENANCE AND SERVICE SAFETY INSTRUCTIONS AND PRACTICES



Perform service, repairs and lubrication according to the maintenance section. Ensure the unit is properly lubricated as specified in the lubrication schedule and all bolts and nuts are properly torqued. Failure to properly service, repair and maintain this Implement in good operating condition could cause component failure and possible serious injury or even death. (SG-35)

# SAFETY

## **WARNING**

Periodically inspect all moving parts for wear and replace when necessary with authorized service parts. Look for loose fasteners, worn or broken parts, and leaky or loose fittings. Make sure all pins are properly secured. Serious injury may occur from not maintaining this equipment in good working order. (SNPM-01)



## **WARNING**

Inspect the entire Snow Plow before each use. Accidents may occur or damage to the equipment may result if the Snow Plow is not maintained in good mechanical working order.

- Check for loose bolts, worn or broken parts, pinched hydraulic hoses, and leaky or loose fittings.
- Make sure all pins are secure and safety pin equipped.
- Make sure replacement parts are the correct size and properly installed.
- Make sure all fluid levels are full and replenish as necessary.
- Make sure fuel, oil, and coolant caps are replaced and tightened.
- Check tire condition for tread wear and tire pressure at the rated PSI.
- Make sure that all safety shields and guards are attached and in good condition.
- Make sure all scheduled maintenance is up to date. (SNPM-02)

## **WARNING**

Do not modify or alter this Snow Plow. Do not permit anyone to modify or alter this equipment, any of its components or any Snow Plow function. Modification can result in equipment failure and cause serious injuries to the operator, coworkers, or bystanders. (SNPM-03)

## **WARNING**

Use extreme care when climbing onto the equipment to perform repairs, maintenance, and cleaning. Use proper stands and ladders to access areas that cannot be reached from ground level. Slipping and falling off the equipment can cause serious injury or death. (SNPM-04)

## **WARNING**

Never attempt to repair, lubricate, adjust, clean, remove obstructions or perform any other type of service to any component while the Snow Plow is in motion or while the engine is running. Completely shut down the engine and wait for all motion to come to a complete stop before servicing the Snow Plow. (SNPM-05)

## **DANGER**

Never leave the Snow Plow unattended while the plow is in the raised position. Accidental operation of the lifting lever or a hydraulic failure may cause a sudden drop of the unit which could result in injury or death by crushing. If the plow must be raised for inspection or service securely block up and support the Plow to prevent it falling. (SNPM-06)

## **DANGER**

Never crawl under the Snow Plow or any raised component unless it is properly blocked up and support to prevent it from falling. Accidental operation of a lifting lever or hydraulic failure may cause a sudden drop of the unit with injury or death by crushing. (SNPM-07)

# SAFETY

## **WARNING**

Use proper protective equipment including gloves, safety eye wear, arm protection when handling plow blades and components during replacement, adjustment, and maintenance. Plow edges and components can become sharp and have burrs that could inflict puncture and cuts to the hands, arms, and/or eyes if proper protective equipment is not worn.

(SNPM-08)

## **WARNING**

Replace bent, cracked, or broken plow blade with a new blade. Never attempt to straighten or weld on plow blades because this will likely crack or otherwise damage the blade with subsequent failure and possible serious injury from broken blade being ejected from plow. (SNPM-10)

## **DANGER**

Escaping pressurized hydraulic oil generated by hydraulic pumps has the potential to inflict serious injury and possible death. Never attempt to repair a pump or hose or tighten a connection while the system is pressurized. Always shut down the engine and relieve hydraulic oil pressure before performing any repairs to the hydraulic system. (SNPM-11)

## **WARNING**

Hydraulic pressure must be relieved from the hydraulic circuit prior to doing any maintenance or repair work and when the Snow Plow is parked at the end of the day. Place the Snow Plow(s) on the ground or securely blocked up. Turn off the Truck engine then engage the hydraulic remote cylinders several times to relieve hydraulic pressure prior to performing any maintenance or repair work. (SNPM-12)

## **WARNING**

Never remove debris from or unclog jams in the plow or lifting components until the engine have been completely shutdown and all components have come to a complete stop and are lowered to ground level and hydraulic pressure relieved. Always wear PPE when removing collected material and debris from the equipment. Serious injury or death may occur if any of these precautions are not followed when removing plugged or entangled debris. (SNPM-15)

## **WARNING**

Engine Exhaust, some of its constituents, and certain vehicle components contain or emit chemicals known to the state of California to cause cancer and birth defects or other reproductive harm. (SNPM-20)

## **DANGER**

Do not operate this equipment with hydraulic oil or fuel leaking. Oil and fuel are expensive and their presence could present a hazard. Do not check for leaks with your hand! High-pressure oil streams from breaks in the line could penetrate the skin and cause tissue damage including gangrene. To check for a hose leak, SHUT the ENGINE OFF and remove all hydraulic pressure. Wear oil impenetrable gloves, safety glasses and use Cardboard to check for evidence of oil leaks. If you suspect a leak, REMOVE the HOSE and have it tested at a Dealer. If oil does penetrate the skin, have the injury treated immediately by a physician knowledgeable and skilled in this procedure. (SNPM-21)



## **WARNING**

Always read carefully and fully comply with the manufacturers instructions when handling fuels, oils, solvents, cleansers, and any other chemical agent. (SNPM-22)

SAFETY

# SAFETY



Battery posts, terminals and related accessories contain lead and lead compounds, chemicals known to the state of California to cause cancer and birth defects or other reproductive harm. Wash Hands after handling. (SNPM-23)



Avoid contact with hot surfaces on the bottom of the skid shoes or plow cutting edges. Use gloves and eye protection when servicing hot components. Contact with a hot surface can cause serious injury from burns or scalding. (SNPM-24)



Remove the negative battery cable from the battery before performing any maintenance on the electrical system to prevent an accidental circuit shorting and sparks. Sparks can result in wiring damaged, fire or personal injury. (SNPM-25)



Before conducting maintenance on the Snow Plow stop the truck or Power Unit, place the transmission in the park position and set the parking brake. Turn the engine off and remove the key to prevent inadvertent or accidental starting of the engine. Unexpected engine start up or vehicle movement can result in serious bodily injuries or death. (SNPM-27)

## TRANSPORTING SAFETY INSTRUCTIONS AND PRACTICES



Transport the Truck, Power Unit, and Snow Plow only at safe speeds. Serious accidents and injuries can result from driving this equipment at unsafe speeds. Become familiar with the driving characteristics of the equipment and how it handles before operating or transporting on streets and highways. Make sure the Truck's or Power Unit's steering, brakes, and wheels are in good condition and operate properly)

Before transporting the Equipment determine the safe transport speeds for you and the machine. Make sure you abide by the following rules:

- Test the Truck or power unit and Snow Plow at a slow speed and increase the speed slowly. Apply the brakes smoothly to determine the stopping characteristics of the Truck equipped with the Snow Plow. As you increase the speed of the Truck, the stopping distance increases. Determine the maximum safe transport speed for you and the equipment. When driving down a hill or on wet or icy roads, the braking distance increases: use extreme care and reduce your speed. Do not operate the equipment with weak or faulty brakes.
- Obey all traffic laws and regulations. Never exceed the posted speed limit.
- The Snow Plow has moved the center of gravity of the equipment forward. Use extreme caution when transporting at highway speeds. Slow down for sharp corners or on slopes to avoid loss of steering control.
- Only transport the equipment at the speeds determined as safe and which allow for proper control of the machine while driving and stopping during an emergency.
- When operating in traffic, use the Truck's or Power Units directional indicator or signal lights to indicate your movement. Always use the flashing warning lights and other equipped warning features to alert motorists of your presence and slow moving speed when operating in traffic. **Be Aware of Traffic Around You and Watch Out for the Other Guy.** (SNPO-09)



# SAFETY

## Federal Laws and Regulations

This section is intended to explain in broad terms the concept and effect of federal laws and regulations concerning employer and employee equipment operators. This section is not intended as a legal interpretation of the law and should not be considered as such.

### Employer-Employee Operator Regulations

U.S. Public Law 91-596 (The Williams-Steiger Occupational and Health Act of 1970) OSHA

#### This Act Seeks:

“...to assure so far as possible every working man and woman in the nation safe and healthful working conditions and to preserve our human resources...”

#### DUTIES

Sec. 5 (a) Each employer-

(1) shall furnish to each of his employees employment and a place of employment which are free from recognized hazards that are causing or are likely to cause death or serious physical harm to his employees;

(2) shall comply with occupational safety and health standards promulgated under this Act.

(b) Each employee shall comply with occupational safety and health standards and all rules, regulations and orders issued pursuant to this Act which are applicable to his own actions and conduct.

#### OSHA Regulations

OSHA regulations state in part: “At the time of initial assignment and at least annually thereafter, the employer shall instruct every employee in the safe operation and servicing of all equipment with which the employee is, or will be involved.”

#### Employer Responsibilities:

To ensure employee safety during plow and truck or other power unit operation, it is the employer’s responsibility to:

1. Train the employee in the proper and safe operation of the plow and truck or other power unit.
2. Require that the employee read and fully understand the plow and truck or other power unit Operator’s manual.
3. Permit only qualified and properly trained employees to operate the plow and truck or other power unit.
4. Maintain the plow and truck or other power unit in a safe operational condition and maintain all shields and guards on the equipment.
5. Ensure the truck or other power unit is equipped with a functional ROPS and seat belt and require that the employee operator securely fasten the safety belt and operate with the ROPS in the raised position at all times.
6. Forbid the employee operator to carry additional riders on the Tractor or Implement.
7. Provide the required tools to maintain the plow and truck or other power unit in a good safe working condition and provide the necessary support devices to secure the equipment safely while performing repairs and service.
8. Require that the employee operator stop operating equipment if bystanders or passersby come within 25 feet.

#### Child Labor Under 16 Years of Age

Some regulations specify that no one under the age of 16 may operate power machinery. It is your responsibility to know what these regulations are in your own area or situation. (Refer to U.S. Dept. of Labor, Employment Standard Administration, Wage & Home Division, Child Labor Bulletin #102.)

## DECALS

# STB – SCARIFIER TOOL BAR

### Attachments Items (No Decals)

Part No.	Qty.	Description
7330012	1	Serial Number Tag
7300047	1	Product Manual Canister
7300048	1	Plug - Product Manual Canister

### Instructions:

Follow these instructions to position the above items to your Henke product for safety and professional appearance. Apply on clean surfaces only. They should be properly applied and kept in good condition. If a decal is worn out, torn, or otherwise defaced, call us for an immediate replacement at 1-913-682-9000, or 1-888-682-9010.

## DECALS

1. Position Canister 73300047 as shown ABOVE Serial Tag in location shown.

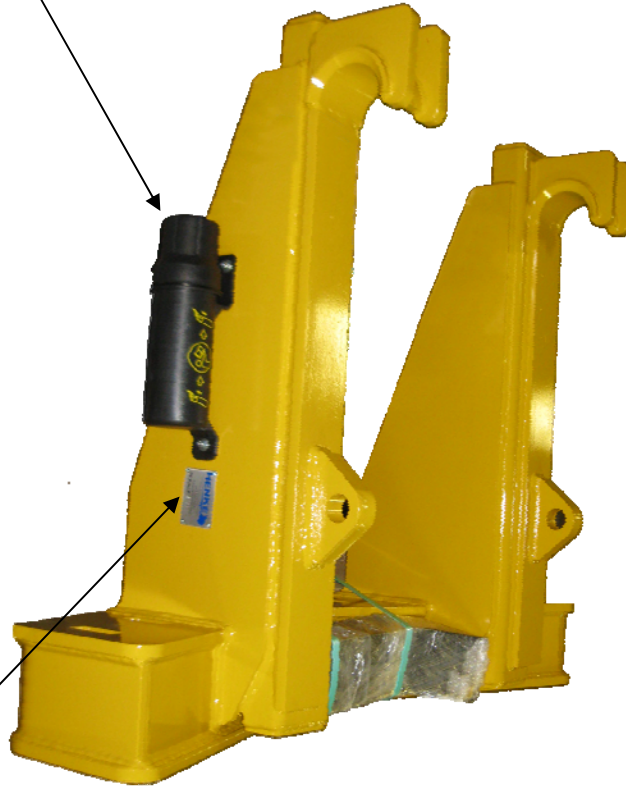

2. Position 7330012 Serial Tag as shown on Driver's Side.

## IN SEASON MAINTENANCE

Snow removal equipment must be cared for and maintained regularly. Daily or pre-route inspection and maintenance are necessary. Failure to do so may affect efficiency and safety.

A visual inspection must be carried out after every 8 hours of operation. Look for damaged components, bends, cracked welds or hydraulic leaks. **REPAIR IMMEDIATELY!** It is recommended to re-torque all bolts after the first 8 hours of use and to regularly check for loosened or missing fasteners. Replace any damaged or missing fasteners immediately.

Because of the environment in which snow equipment is expected to operate, hydraulic lines, fasteners, wearable or replaceable items and warning decals may become damaged by snow, ice and road debris. These items must be inspected daily and replaced if necessary to avoid equipment damage or personal injury.

Lubrication of moving parts is of the utmost importance. Exposure to snow, ice, salt and road debris will wash away lubrication quickly and it may be necessary to inspect and reapply lubrication more than once a day.

# END OF SEASON MAINTENANCE

## GROUND ENGAGING COMPONENTS

- **CUTTING EDGES & GUARDS:** Replace any broken cutting edges, unevenly or excessively worn cutting edges, and broken or worn wear guards.
- **RUNNING GEAR:** Replace broken, worn, or missing running gear shoes, and any damaged adjuster leg components. Grease internal threads and sliding members (it's best to disassemble and grease directly; zerks aren't as effective at greasing these areas).
- **HARDWARE:** Replace missing or broken bolts. Proper torque is important! Use grade 8 plow bolts for steel cutting edges.

## HYDRAULICS

- **HOSES:** Plug or cap any QC fittings or any open hose ends. Inspect hoses for any leaks or potential leaks. Secure hoses with hose clamps.
- **CYLINDERS:** Check for leaks, and any chrome rod dents or scratches. Apply a light coat of oil or grease on exposed rod surfaces.

## FRAME AND MOLDBOARD

- **JOINTS:** Check pins, bushings, and pivot bolts for wear. Make sure all keepers are in place. Make sure shear bolts and pins are same as original equipment (usually grade 2). Some drivers don't like replacing shear pins and will install grade 8 replacements to avoid replacing during a storm. These items are designed to shear to protect the driver and the equipment. **CHECK WELDMENTS FOR CRACKS.**

## CABLE AND SHEAVES (IF APPLICABLE)

- **CABLE:** Check cable thoroughly for fraying, kinks, and abnormal wear. Make sure cable is properly routed and seated in all sheaves. Verify that cable clamps have the proper torque and are in the correct orientation and spacing. Cable shall be checked prior to each use or after every 8 hours, whichever comes first.
- **SHEAVES:** Verify that sheave, bushings and retaining pins are in good condition and adequately greased. Make sure that sheaves, bushings and pins do not have any abnormal wear and rotate without restriction.

## REPLACE WORN OR BROKEN PARTS FOUND BY ABOVE INSPECTIONS

<<THIS PAGE IS INTENTIONALLY LEFT BLANK>>

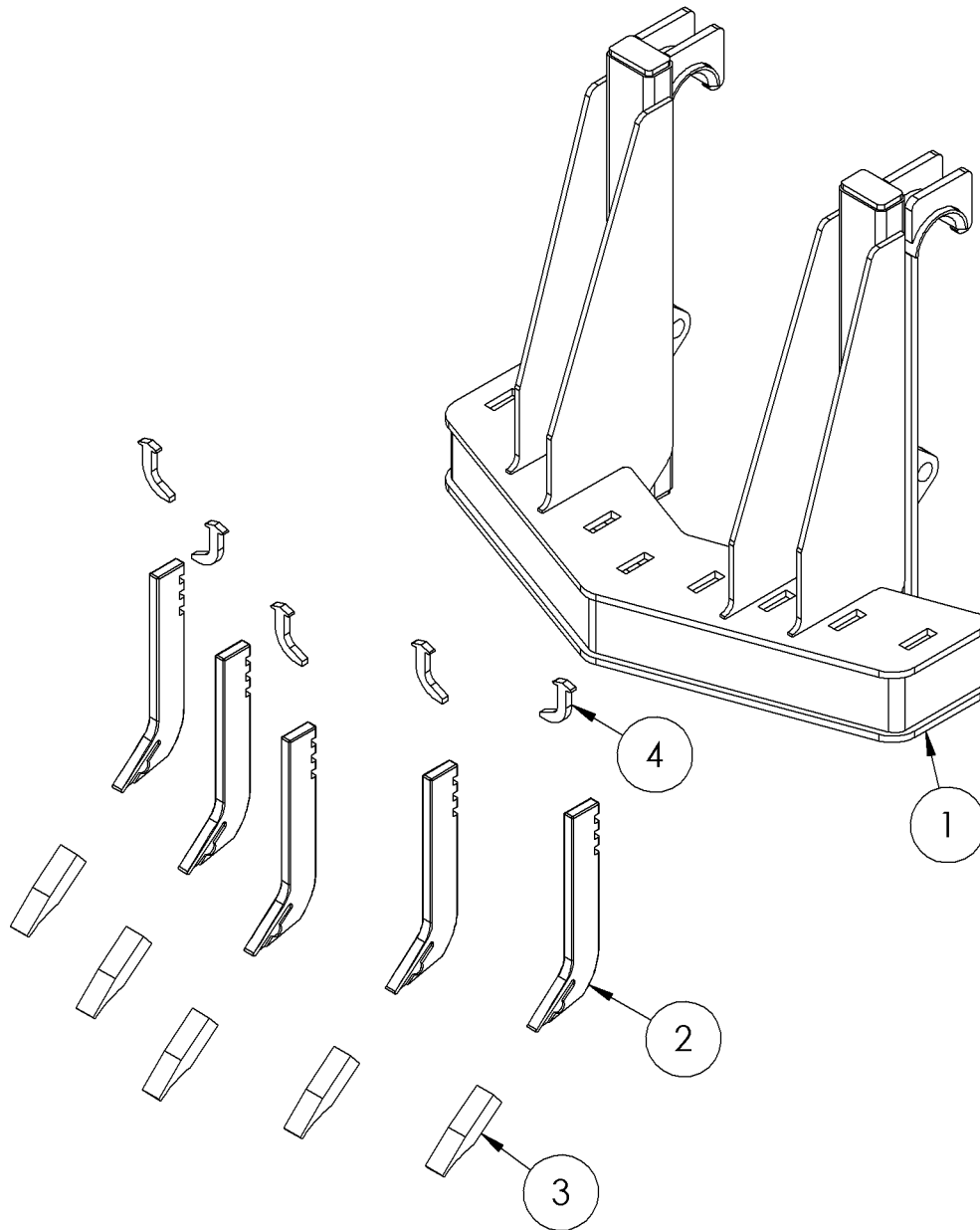

**FIGURE 2 – Scarifier Tool Bar with Parallel Hooks**

**TABLE 1 – Scarifier Tool Bar, Parts List**

ITEM NO.	Qty.	PART NUMBER	DESCRIPTION
1	1	279-0534	Scarifier head Adapter with Balderson Hooks
2	5	7070051	Scarifier Shank
3	5	7070052	Scarifier Tooth
4	5	2700-0580	"J" Wedge

## TABLE 2 – Cutting Edges

6" STEEL	1/2" THICK	5/8" THICK	3/4" THICK
2FT.	Call	7150119	7150189
3FT.	7150153	7150120	7150073
4FT.	7150154	7150129	7150072
5FT.	7150007	7150184	7150026
6FT.	Call	Call	7150004
7FT.	Call	Call	7150028
8FT.	7150172	Call	Call
9FT.	Call	Call	7150036
10FT.	7150008	7150090	7150197
11FT.	7150009	7150089	7150031
12FT.	7150010	7150082	7150032

CP 6" STEEL	1/2" THICK	5/8" THICK	3/4" THICK
3FT.	7150186	Call	Call
4FT.	7150187	Call	Call

CP 10" STEEL	1/2" THICK	5/8" THICK	3/4" THICK
10FT.	Call	Call	7150050

CARBIDE	3/4" THICK
3FT.X5" TALL	Call
3FT.X6" TALL	7150035
3FT.X8" TALL	7150163
4FT.X5" TALL	7150123
4FT.X6" TALL	7150025
4FT.X8" TALL	7150164
5FT.X8" TALL	7150097
6FT.X6" TALL	7150124

8" STEEL	1/2" THICK	5/8" THICK	3/4" THICK
2FT.	7150039	7150077	Call
3FT.	7150037	7150078	Call
4FT.	7150038	7150079	Call
5FT.	7150011	Call	7150054
6FT.	7150005	7150081	7150055
8FT.	7150012	Call	7150042
9FT.	7150013	7150045	7150046
10FT.	7150014	7150043	7150047
11FT.	7150015	7150040	7150048
12FT.	7150016	7150044	7150049

CP 8" STEEL	1/2" THICK	5/8" THICK	3/4" THICK
3FT.	7150021	Call	Call
4FT.	7150022	Call	Call
10FT.	7150017	Call	7150171
11FT.	7150018	7150169	Call
12FT.	7150019	7150056	Call

RUBBER Notes 5&6	1 1/2" THICK X10" Tall CP	RETAINING STRIP
8FT.	3500-0008	3500-0026
9FT.	3500-0009	1300-2223
10FT.	3500-0010	1300-0394
11FT.	3500-0011	1300-0395
12FT.	3500-0012	1300-0396
14FT.	3500-0014	1300-0401
16FT.	3500-0016	1300-0402

SNOW BASKET	1" THICK X10" Tall CP
8FT.	7150052
9FT.	7150053
10FT.	7150088

**NOTES:**

1. For Cutting Edges Not Listed Call Henke Manufacturing at 1-888-682-9010.
2. Except as noted, all cutting edges have 1.5" gauge line (distance from top edge to center of holes)
3. "CP" = Center Punched
4. All edges shown are punched for 5/8" bolts.
5. For rubber cutting edges, 6" tall center punched steel edges, Items 7150186 & 7150187 may be used to provide proper support behind the rubber edge.
6. Henke's rubber cutting edges feature a minimum tensile strength of 2000 psi and a maximum DIN rating of 150, and last much longer in service than lower quality rubber cutting edges available from some other suppliers.
7. Polyurethane cutting edges also available - call for price and availability.



**TABLE 3 – Cutting Edge Hardware**

<b>TYPE</b>	<b>LENGTH</b>	<b>PART NO.</b>	<b>USES/NOTES</b>
<b>PLOWBOLTS 5/8-11 GRADE 8</b>	2"	7150001	FOR STANDARD CUTTING EDGES AND WEAR GUARDS
	2 ½"	7150003	
	3"	7150002	
	3 ½"	7150103	
	4"	7150105	
	4 ½"	7150106	
	5"	7150108	
<b>CARRIAGE BOLTS 5/8-11 GRADE 8</b>	3"	7020280	FOR SOME WRAPAROUND CURB GUARDS (SQUARE HOLES, NOT COUNTER SUNK)
	4"	7020287	
	5"	7020359	
	6"	7020363	
<b>HEX BOLTS</b>	4"	7020064	RUBBER AND POLY CUTTING EDGES (USE NYLOCK NUTS ONLY)
	4 ½"	7020128	
	5"	7020295	
<b>TOPLOCK NUT 5/8-11 GRADE C</b>	N/A	7030084	USE WITH STEEL OR CARBIDE CUTTING EDGES
<b>NYLOCK NUT 5/8-11 GRADE 8</b>	N/A	7030095	USE WITH RUBBER OR POLY CUTTING EDGES

## TABLE 4 – Henke Curb Guards & Wear Guards

### Wrap-Around Curb Guards, Steel

	7150122	6", Left
	7150121	6", Right
	7150117	8", Reversible

### Wrap-Around Curb Guards, Chrome-Carbide Weld Deposit on Wrap-Around Corner

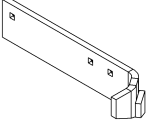
	7150125	6", Left
	7150126	6", Right
	7150115	8", Left
	7150118	8", Right

### Wrap-Around Curb Guard + Wear Guard, Chrome-Carbide Weld Deposit on Wrap-Around Corner + on Bottom Wear Edge

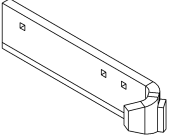
	7150113	6", Left
	7150114	6", Right
	7150130	8", Left
	7150131	8", Right

### Bolt-On Curb Guards (Bolts to Outside of End Rib)

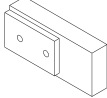
	139-1046	Bolt-On Guard Assy.
	1300-1633	Optional spacer (Required for Tripedge applications)

### Henke Wear Guards and Wear Shoes

#### Wear Guards, Standard Length (9"), with Chrome-Carbide Weld Deposit (Mount in front of cutting edge)

	7140106	6", Reversible
	7140107	8", Reversible

#### Wear Guards, Long Length (21"), with Chrome-Carbide Weld Deposit (Mount in front of cutting edge)

	7140108	6", Reversible
	7140008	8", Reversible

#### Cast Wear Shoes (Mount behind cutting edge)w

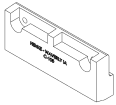
	7140004	Wear shoe for 6" cutting edges, or 8" center-punched edges
	7140002	Wear shoe for 8" cutting edges

#### Bottom Angle Saver (Mount behind of Bottom Angle)

	199-0280	Bottom Angle Saver with Carbide Strip
---	----------	---------------------------------------

# HENKE

## LIMITED WARRANTY

### 1. LIMITED WARRANTIES

- 1.01. Henke warrants for one year from the purchase date to the original non-commercial, governmental, or municipal purchaser ("Purchaser") and warrants for twelve months to the original commercial or industrial purchaser
- 1.02. Manufacturer will repair or replace for the Purchaser any part or parts found, upon examination at one of its factories, to be defective under normal use and service due to defects in material or workmanship.
- 1.03. This limited warranty does not apply to any part of the goods which has been subjected to improper or abnormal use, negligence, alteration, modification, or accident, damaged due to lack of maintenance or use of wrong fuel, oil, or lubricants, or which has served its normal life. This warranty does not include normal wear items such as cutting edges, wear guards, scarifier teeth, etc. or improper installation. HMC warranty for any purchased components, such as hydraulic cylinders will be superceded by, and equal to the component manufacturer warranty.
- 1.04. Except as provided herein, no employee, agent, Dealer, or other person is authorized to give any warranties of any nature on behalf of Manufacturer.

### 2. REMEDIES AND PROCEDURES.

- 2.01. Warranty claims must be filled within 30 days of repair work during the one year warranty period and will be honored only if the completed warranty registration form has been returned. Henke reserves the right to require proof of purchase of original Henke replacement parts. If warranty is approved any allowed shipping expenses will be based on and will not exceed standard base shipping charges.
- 2.02. Purchaser claims must be made in writing to the Authorized Dealer ("Dealer") from whom Purchaser purchased the goods or an approved Authorized Dealer ("Dealer") within 30 days after Purchaser learns of the facts on which the claim is based.
- 2.03. Purchaser is responsible for returning the goods in question to the Dealer.
- 2.04. If after examining the goods and/or parts in question, Manufacturer finds them to be defective under normal use and service due to defects in material or workmanship, Manufacturer will:
  - (a) Repair or replace the defective goods or part(s) or
  - (b) Reimburse Purchaser for the cost of the part(s) and reasonable labor charges (as determined by Manufacturer) if Purchaser paid for the repair and/or replacement prior to the final determination of applicability of the warranty by Manufacturer.

The choice of remedy shall belong to Manufacturer.

- 2.05. Purchaser is responsible for any labor charges exceeding a reasonable amount as determined by Manufacturer and for returning the goods to the Dealer, whether or not the claim is approved. Purchaser is responsible for the transportation cost for the goods or part(s) from the Dealer to the designated factory.

### 3. LIMITATION OF LIABILITY.

- 3.01. MANUFACTURER DISCLAIMS ANY EXPRESS (EXCEPT AS SET FORTH HEREIN) AND IMPLIED WARRANTIES WITH RESPECT TO THE GOODS INCLUDING, BUT NOT LIMITED TO, MERCHANTABILITY AND FITNESS FOR A PARTICULAR PURPOSE.
- 3.02. MANUFACTURER MAKES NO WARRANTY AS TO THE DESIGN, CAPABILITY, CAPACITY, OR SUITABILITY FOR USE OF THE GOODS.
- 3.03. EXCEPT AS PROVIDED HEREIN, MANUFACTURER SHALL HAVE NO LIABILITY OR RESPONSIBILITY TO PURCHASER OR ANY OTHER PERSON OR ENTITY WITH RESPECT TO ANY LIABILITY, LOSS, OR DAMAGE CAUSED OR ALLEGED TO BE CAUSED DIRECTLY OR INDIRECTLY BY THE GOODS INCLUDING, BUT NOT LIMITED TO, ANY INDIRECT, SPECIAL, CONSEQUENTIAL, OR INCIDENTAL DAMAGES RESULTING FROM THE USE OR OPERATION OF THE GOODS OR ANY BREACH OF THIS WARRANTY. NOTWITHSTANDING THE ABOVE LIMITATIONS AND WARRANTIES, MANUFACTURER'S LIABILITY HEREUNDER FOR DAMAGES INCURRED BY PURCHASER OR OTHERS SHALL NOT EXCEED THE PRICE OF THE GOODS.
- 3.04. NO ACTION ARISING OUT OF ANY CLAIMED BREACH OF THIS WARRANTY OR TRANSACTIONS UNDER THIS WARRANTY MAY BE BROUGHT MORE THAN TWO (2) YEARS AFTER THE CAUSE OF ACTION HAS OCCURRED.

### 4. MISCELLANEOUS.

- 4.01. Proper Venue for any lawsuits arising from or related to this limited warranty shall be only in Leavenworth County, Kansas.
- 4.02. Manufacturer may waive compliance with any of the terms of this limited warranty, but no waiver of any terms shall be deemed to be a waiver of any other term.
- 4.03. If any provision of this limited warranty shall violate any applicable law and is held to be unenforceable, then the invalidity of such provision shall not invalidate any other provisions herein.
- 4.04. Applicable law may provide rights and benefits to purchaser in addition to those provided herein.

KEEP FOR YOUR RECORDS

ATTENTION: Purchaser should fill in the blanks below for his reference when buying repair parts and/or for proper machine identification when applying for warranty.

Henke Implement Model \_\_\_\_\_ Serial Number \_\_\_\_\_  
Date Purchased \_\_\_\_\_ Dealer \_\_\_\_\_

ATTENTION:

READ YOUR OPERATOR'S MANUAL

**HENKE MANUFACTURING**

An Alamo Group Company

3070 Wilson

Leavenworth, KS 66048

888-682-0300



## DEALER WARRANTY PROCEDURE

**For units delivered within the past 12 months, report any warranty problems needing repair to our Product support department. Have information ready regarding:**

1. Henke unit model and serial number,
2. Model of equipment Henke unit is attached to (prime mover)
3. Description of the problem and any helpful information by the end user. (Photos are always helpful).

Measurements or photos may be requested by Henke engineering for any issues regarding prime mover proximity and clearance, or any other unique considerations of fit and adaptability. These may be necessary for a proper repair recommendation and procedure.

Henke will respond with a written labor hour allowance for Henke participation on a faxed claim form and will ship any required replacement parts. If necessary, a repair procedure will be included on the claim form. A parts invoice will be generated to confirm shipment of the replacement parts.

If defective parts are needed for analysis, Henke will request their return.

Any such returned items are to be labeled with the **claim number** and returned to:

**Henke Manufacturing Corp**  
**ATTN: Product support**  
**3070 Wilson Av**  
**Leavenworth, Ks. 66048**  
**RGA#\_\_\_\_\_**

The dealer should perform repairs as agreed on a dealer warranty repair order. Return the claim form with a copy of the dealer warranty repair order and service report. Credit as agreed will be issued to the dealer upon receipt of the dealer warranty repair order invoice (Pro-forma invoice), and upon receipt, inspection and warranty confirmation of the returned parts if any.

### **Parts & Service Assistance**

Parts and service assistance is available between the hours of **8:00 AM and 5:00 PM**, Central time, Monday through Friday. **Call 913-682-9000.**

Our web site, **www.henkemfg.com**, is a quick source for parts pricing and many common parts diagrams

Parts purchase orders may be faxed in at any time to **913-682-0300**. Faxed orders are encouraged, as they help insure order accuracy and follow up. Include any special instructions, such as drop ship addresses on your order.